



**TURBO**

CULTIVATOR FOR ALL SEASONS

# WHEN FARMING MEANS BUSINESS

Realising the full potential of farming is about growing and developing your business, not only your crop or livestock, but also your profit. Improve productivity and profitability by focusing on the positives and minimising disadvantageous aspects, through strong, dedicated management.

Success springs from determination and clear targets, from laying down the appropriate strategy and allocating correct investments for the future. Quality results require the right ideas and equipment. When there is work to be done, you need the optimal setup and smart solutions that support you towards an easier, more profitable way of working. You need solutions that make tough and demanding conditions less complicated.





## TILLAGE

Preparing and cultivating your soil in order to achieve the highest possible yield is about choosing the correct tillage system.

# YOUR KVERNELAND

## INTELLIGENT FARMING SOLUTIONS

Choose the best farming solution for you and your land. Combine the highest possible yields with sustainability. This will start with the correct tillage. The choices you make depend on various factors and should match your specific circumstances, like soil structure, crop rotation, residue management, economic and ecological viabilities.

*The choice is yours!*

You must consider environmental and legal issues. From conventional methods to conservation tillage: the balance of operations at the right time has to be found to achieve high yields with the best soil condition (air, moisture, biological activity, etc.) with a minimum amount of energy, time and investment. For this, Kverneland offers a full range of intelligent farming solutions.

### CONVENTIONAL TILLAGE

#### Conventional Tillage

- **Intensive** method of cultivation
- Complete soil inversion e.g. by a plough
- Less than 15-30% crop residues left on soil surface
- Seedbed preparation done by an active tool or special seedbed harrow
- High phytosanitary effect by reduced pressure of weed and fungi diseases - fewer herbicides and fungicides needed
- Better dry-off and faster increase of soil temperature for better nutrients absorption

### CONSERVATION TILLAGE

#### Mulch Tillage



























- **Reduced** intensity in terms of depth and frequency
- More than 30% of residues are left on soil surface
- Extended repose period of the soil
- Cultivator and/or discs incorporate the crop residues within the top 10cm of soil for stable bearing soil
- Full-width tillage - seedbed preparation and seeding in one pass
- Protection against soil erosion; reduce soil loss by run-off and improve water storage capacity.
- Improvement of soil moisture retention

#### Strip Tillage

- **Zonal strip loosening** before or during seeding of up to 1/3 of the row width (Loibl, 2006). Up to 70% of the soil surface remains untouched
- Strip-till combines the soil drying and warming benefits of conventional tillage with the soil-protecting advantages of no-till by disturbing only the area of the soil where the seeds are placed
- Exact fertilising deposit
- Soil protection against erosion and drought

#### Vertical Tillage / No-Till

- **Extensive** method
- Working soil vertically avoids additional horizontal layers or density changes
- Increasing water infiltration, root development and nutrient take-up
- Plants' roots dictate the overall health of the plant, as they deliver nutrients and water throughout the season, contributing to a higher yield
- A strong set of roots make plants more resistant to wind and drought.
- Lower energy input required

KVERNELAND'S INTELLIGENT FARMING SOLUTION			Method	Deep Tillage (not a must)	Basic Tillage	Seedbed Preparation	Seeding	Spreading	Spraying
CROP ESTABLISHMENT SYSTEMS	CONSERVATION	extensive	Vertical Tillage shallow tillage						
		> 30% Soil coverage after Seeding	Strip Tillage stripwise loosening						
	CONVENTIONAL	intensive	up to 15% Conventional with soil inversion						
	15 - 30% Reduced Till without soil inversion								
		Mulch Seeding without soil inversion							

CLASSIFICATION OF TILLAGE METHODS KVERNELAND (Source: adapted from KTBL)



SPEED

STRENGTH

SIMPLICITY

EFFICIENCY



## HIGH PERFORMANCE

# SPEED UP WHEN THE TIME IS RIGHT

### **Speed**

Depending on the season and conditions, you want to leave a rough surface or a fine seedbed. When the time is right, you need a machine that has the right capacity to finish the job. Tomorrow conditions may be worse, so speed is important, to relieve your time pressure.

### **Simplicity**

You want a multifunctional cultivator and to be able to adjust it to the very specific conditions. For seedbed preparation, first and second stubbling operations. Adjustment of the Turbo is simple and operator-friendly.

### **Strength**

You want a machine that lasts, that copes with the stress on the material over a long time. Still you don't want extra weight. With the automatic load transfer system of the Turbo, the pulling traction has been reduced. Better traction of the tractor means saving on fuel and tires.

### **Efficiency**

Soil structure is not the same on every field. You want the best equipment for your specific conditions. We offer a large range of accessories to meet your requirements.

*Perfect soil preparation at lower costs.*

# CULTIVATION AND SEEDBED PREPARATION

## THE CULTIVATOR FOR ALL SEASONS

Powerful and efficient performance - that is what the Turbo offers. The machine can operate at high forward speeds whilst maintaining a consistent working depth.

With the Turbo, Kverneland provides a cultivator which is the right choice for all seasons, all kind of conditions and for a wide field of applications.

In fact, the Turbo range is dedicated for the following seasonal jobs:

### In spring time:

- Opening the soil after frost or winter rainfalls, enhancing the air flow for quicker warming up
- Seedbed preparation in front of spring seeding, for example maize crops that need deeper cultivation for a good root development

### In summer season:

- Stubble cultivation right after harvest
- Second or third pass to destroy weeds and volunteers saving herbicide

### In autumn season:

- Preparing the soil for a fine crumbled seedbed able to enhance germination even for fine seeds like rape, grass etc.

*Versatility is key.*





## HIGH PERFORMANCE CULTIVATOR



Turbo T trailed in 6.50 and 8.00m  
the high-end solution

Turbo fold 4.00, 5.00 and 6.00m  
large working-width for higher  
output

Turbo mounted in 3.00 and  
3.50m width. Compact and  
powerful.

## CULTIVATION FROM DEEP TO SHALLOW FULL RANGE AVAILABLE

The Turbo is the machine on the farm for establishing and making cultivation from 3cm to 20cm. Kverneland proposes different configurations depending of the conditions of use, but also the power ability:

- Turbo: 2 rigid models in 3.00m and 3.50m - up to 175hp
- Turbo F: 3 fold models in 4.00m, 5.00m and 6.00m - up to 300hp
- Turbo T: 2 trailed models in 6.50m and 8.00m - up to 450hp

The **mounted Turbo and Turbo F** have a very compact design to consider the lifting capacity of the tractor. Therefore the tines are staggered on 4 rows, and the first and last row of tines have been placed directly on the frame box sections. The row distance of the tines varies from 550 to 600mm for a low lifting capacity while ensuring a good soil flow. For instance, the 3.00m Turbo equipped with levelling tines and cage roller only requires 2.4T lifting capacity (only 800kg/m).

The **Turbo T** has a well organised tine arrangement over 5 rows. The capacity with long residues has really been a focus during the design process: The row distance varies between 510mm to 900mm; the tine position has been optimised to ensure a smooth soil flow across the entire working width but also around the transport wheels.

*High performance at high speeds.*

- Complete cutting
- Perfect mixing & levelling
- Low pulling force needed
- Wide range of rollers
- Reduced maintenance
- Versatile from shallow to medium
- Large performance by high speed
- Stone protection

## 3 STEPS TO GET A FINE SEEDBED READY THE TURBO CONCEPT

On farms the Turbo becomes a reliable implement essential for all operations without making pans! The range of operations is versatile (3-20cm) from seedbed cultivation due to its narrow tine pitch to stubble cultivation due to the strong tine capacity and high underbeam clearance of 725mm. With the Turbo, you optimise the use of tractor horse power and maximise the performance at lower costs.

*High quality soil cultivation.*

1

### **Tillage the soil**

The Kverneland Turbo is offering a 4 row configuration on the mounted machines and even 5 rows of tines on the trailed version. In combination with the 19cm tine distance, this leads to a nice mixing and finishing without the risk of blockages. The Turbo can be equipped with two different tines (Reflex tine or Triflex tine) and a variation of shares to adjust the machine to different conditions and tasks.

2

### **Levelling the soil**

The Kverneland Turbo is offering the choice between a levelling tine and a disc system. Both units are spring-loaded and can be adjusted in their aggressiveness. Also the angle to the ground can be adjusted. In combination with special border equipment, a perfect levelling is achieved.

3

### **Consolidating the soil**

The third step of perfect seedbed preparation is soil consolidation. Therefore, a wide range of rollers are available to meet the various conditions and requirements.

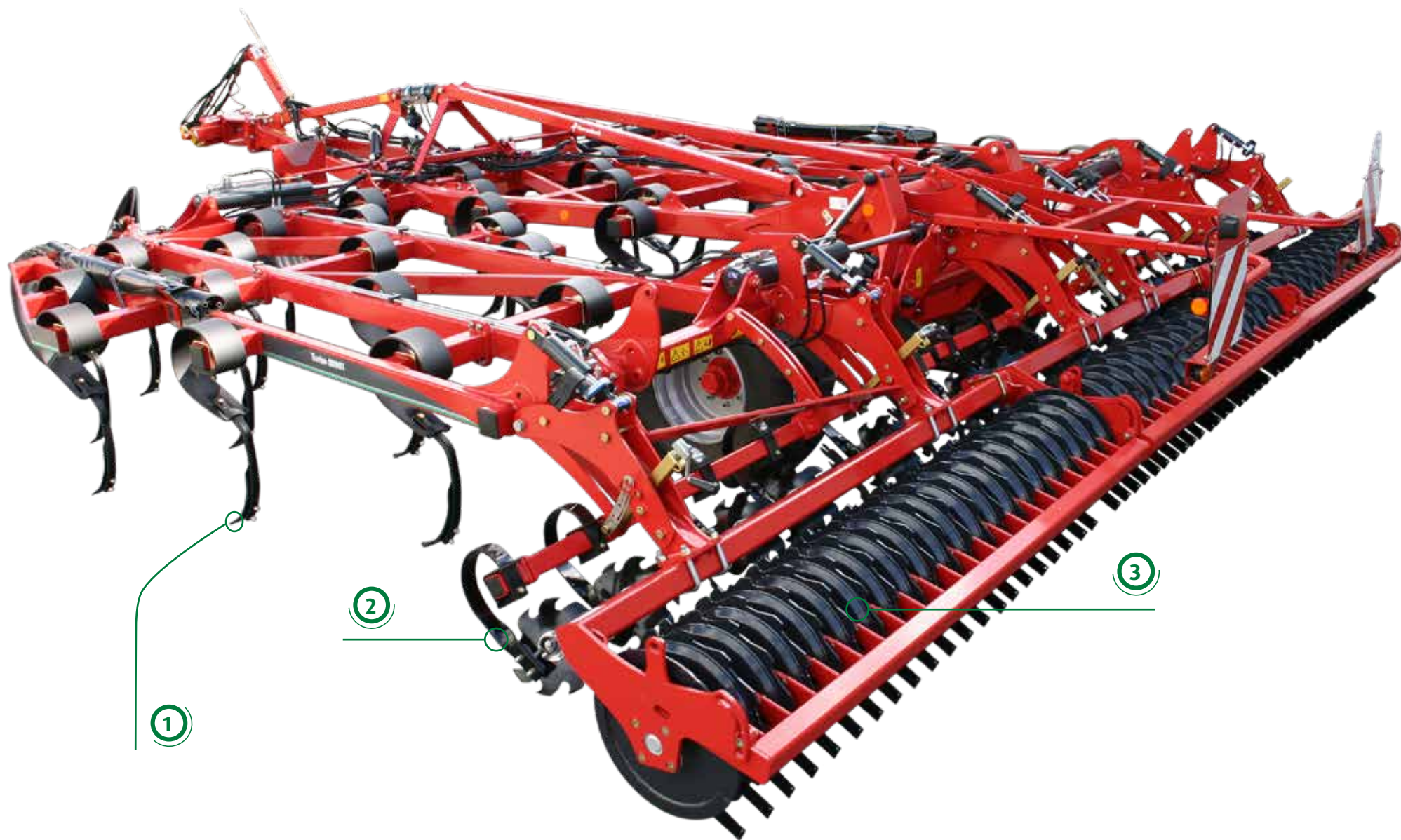

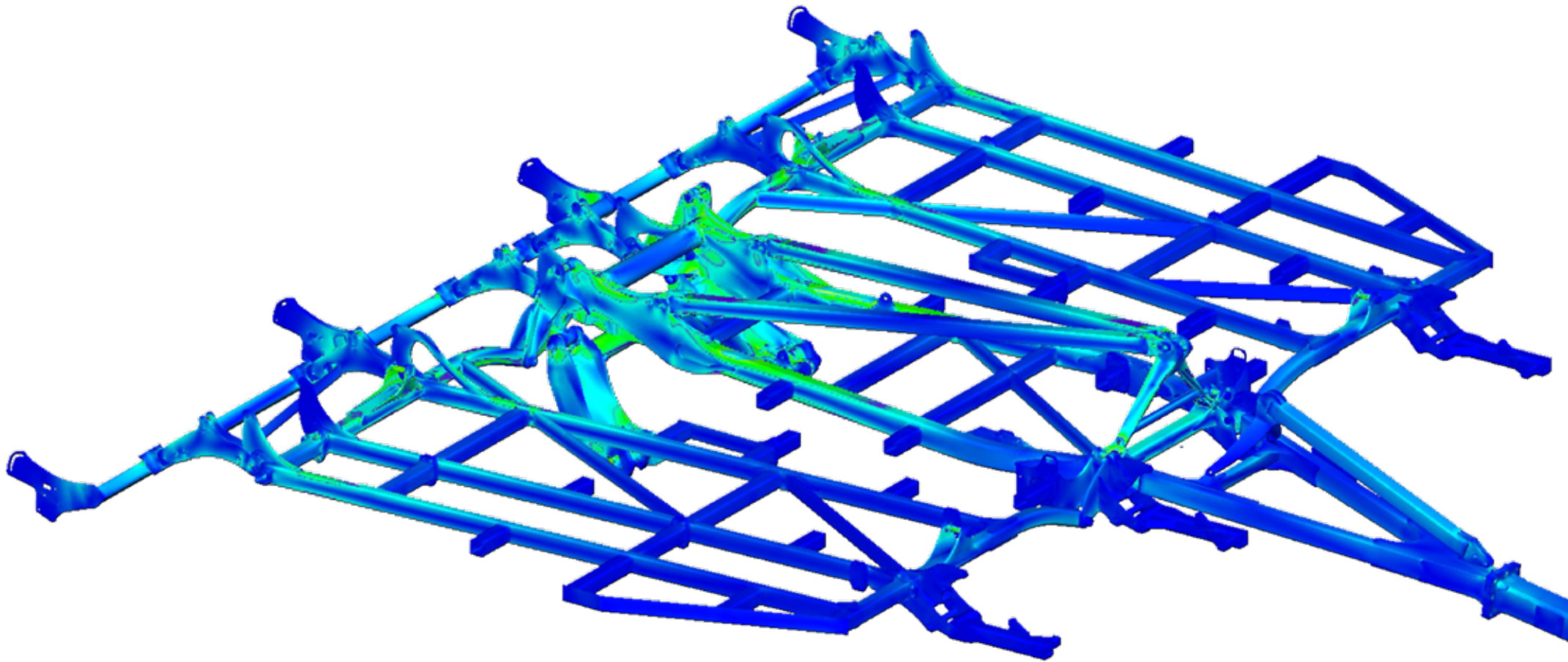

# STRENGTH AND DURABILITY

## ADVANCED TESTING PROGRAM

Before the Turbo was launched into the market, it had passed a whole series of tests to ensure the impeccable quality of the product.

- Sophisticated technologies are used for each development such as static load test, finite elements method (FEM) and shake-lifetime tests.
- Finally the machines are tested in the field under different conditions to reconfirm that the requirements to all functions and strength are met. A strict LOR is defined to meet all kind of soil conditions.

### *Proven Reliability.*

The frame is a result of a long study made by **FEM (Finite Element Method)** calculation to optimise the steel over the working width and proposing a strong structure able to resist to tractors up to 450hp for the trailed model, up to 300hp for the Turbo F and up to 175hp for the rigid frame.

The complete Turbo range has been designed to be combined with the Actipack roller, which is the heaviest roller in the range. All the most aggressive scenarios (deep working when turning, headland turns, transport tests, ...) have been considered to make the different frames as strong as possible and thus guaranteeing the proven Kverneland quality.

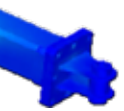
- 
- **Strength**
  - **Long lifetime**
  - **Reliable design**
  - **Proven performance**

# USER COMFORT IS KEY

## EASY ADJUSTMENT

Kverneland always focuses on safe operation and user comfort. With all the adjustments being done without the need for tools, a lot of precious time is saved!

Adjusting the Turbo for each season is easily done. The depth is adjusted by hydraulic cylinders and spacers; the levelling equipment by spindle. If the working depth is changed, there is almost no need to change the position of the levelling equipment thanks to the well-studied cinematic which acts like a parallelogram.

In addition, there is hardly any maintenance to be done on the Turbo apart from changing wearing parts. For farmers with small fields, narrow roads and who want to save time, the rigid Turbo can be equipped with a hydraulic folding system of the lateral levelling tines.

*With up to 1,800kg improved traction.*

### Automatic Load Transfer (ALT) on Turbo T

With the Turbo T, Kverneland provides a cultivator which is easy to pull at low operating costs. A top feature of the Turbo T is the **Automatic Load Transfer (ALT)** system. With the front depth wheels acting like detectors, a sensor activates the load transfer system which transfers up to 1,800kg onto the drawbar. The benefit is up to **5% reduced slippage and savings of almost 900€ per year** (calculated on 1000ha acreage). Additional weight on the tractor (e.g. inside the rim wheels) becomes obsolete – reducing fuel consumption and wearing. The wheel wagon is placed inside the machine to ensure very short headland turnings of less than 10m. This also supports the positive weight transfer on the drawbar even when reversing with the heaviest rollers.

Turbo T 8.00m	with load transfer	without load transfer
Slip (%)	10	15
Forward speed (km/h)	9.0	8.5
Realised ha/h	6.57	6.20

Saving calculation based on 1000ha/year	
Difference (ha/h)	0.37
Difference (ha/day) - 10h/day	3.65
Converted in hour - 10h/day	0,59
Cost of the tractor/hour - 350hp*	66.00€
DGPS (€/ha)*	5.00€
Drivers cost (€/h)	23.00€
<b>Total tractor cost with driver (€/h)</b>	<b>94.00€</b>
<b>€ saving per day (tractor + driver)</b>	<b>55.29€</b>
No. of hours (use/season)	161.25
No. of days of usage	16.12
<b>Total savings per year</b>	<b>891.61 €</b>

\* Based on 500h/year





725MM

High underbeam clearance for blockage free operation

< 60MM

Rings and knives of the Actipack at less than 60mm distance!

190MM

Pich of 190mm for a perfect mixture and finishing.

≤ 1800KG

Best traction due to automatic load transfer (ALT) up to 1800kg to the tractor.

A red Kverneland Turbo 3000 harrow is shown in operation, cutting through a field of tall grass. The machine is moving from left to right, and a large cloud of dust and grass is being kicked up behind it. The harrow's frame is red, and the brand name and model number are visible on a black panel. A white line with a circle at the end points to a specific part of the harrow's frame.

UP TO 200KG

Release force for high  
vibrating effect and  
selfprotection  
face to stones

- High vibration
- Intensive mixing and crumbling
- Constant cutting depth
- Low pulling force
- Deep and shallow

# HIGH VIBRATION FOR INTENSIVE MIXING AND CRUMBLING

## REFLEX TINE: VERSATILE FOR ALL CONDITIONS

### High vibration, narrow spacing, efficient crumbling

The **Reflex tine** benefits from high vibration effect: the large coil and the high tine clearance of 725mm gives a high flexibility whilst ensuring a high vibration effect to crack the clods and mix the soil. The working depth of the share stays even when the tine release to the back thanks to its stable design. The narrow tine spacing ensures active crumbling and perfect levelling. Thus the pressure applied on the coil is reduced to extend its life time.

*Most stable tine up to 20cm deep.*

The Reflex tine is the perfect solution for using the Turbo in first/second stubble pass or for seedbed preparation. Also for the incorporation of slurry or manure the Reflex tine is the best choice. To make it even more versatile three different shares are available.

- Stable cut at shallow depth
- Vibration effect and high release force
- Stone protection

The share works only 7mm higher if the tine goes 150mm backwards.

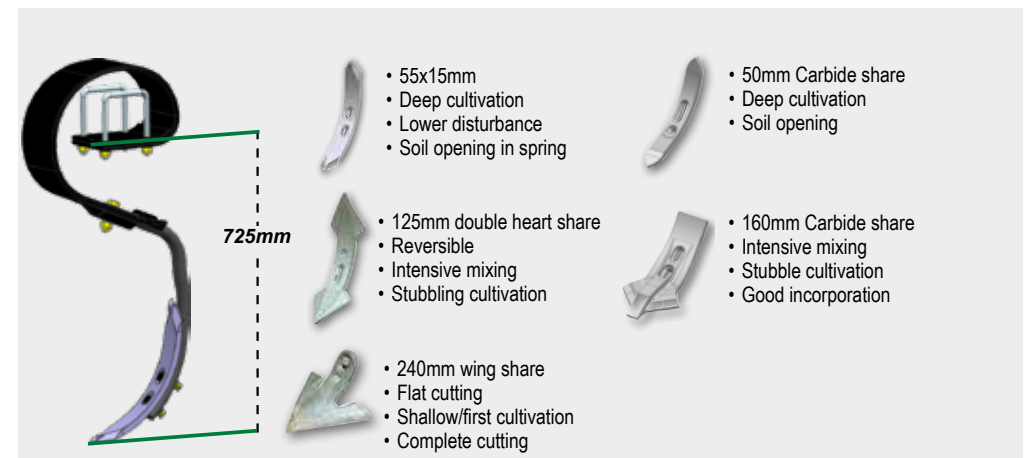
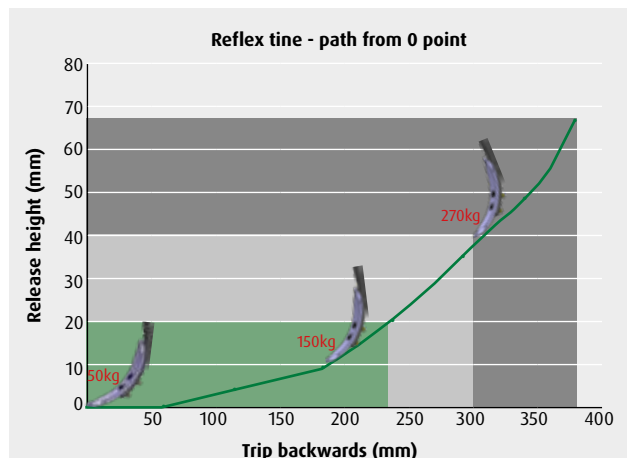



400KG

Penetration force

 **Kverneland Turbo 5000F**

- 400kg release force with Kverneland Triflex tine
- Proven overload-protection
- Intensive mixing and crumbling
- Constant cutting depth
- Deep and shallow - full share range
- Knock-on® system for fast share exchange

# FOR STONY CONDITIONS AND HIGH PENETRATION

## TRIFLEX TINE 400: HIGH STABILITY AT DEEP OPERATIONS

The auto-reset Triflex tine uses the well known **Kverneland leaf spring system** to ensure a high point pressure of 400kg in work and a smooth release curve when the tine hits an obstacle. The Triflex tine with narrow design and special shape reduces the pulling forces while ensuring a perfect penetration in most compacted soil. It is the perfect choice for deep loosening and working on heavier soil types strewn with stones.

*Proven leaf spring and Knock-on® system.*

The Triflex tine can be equipped with different shares to adapt to different working depths and tasks. 3 types of shares are available with the patented Knock-on® system. It is the easiest way of changing parts on a cultivator, either to adapt the machine to the job to be done or to change wearing parts.

**KNOCK-ON**

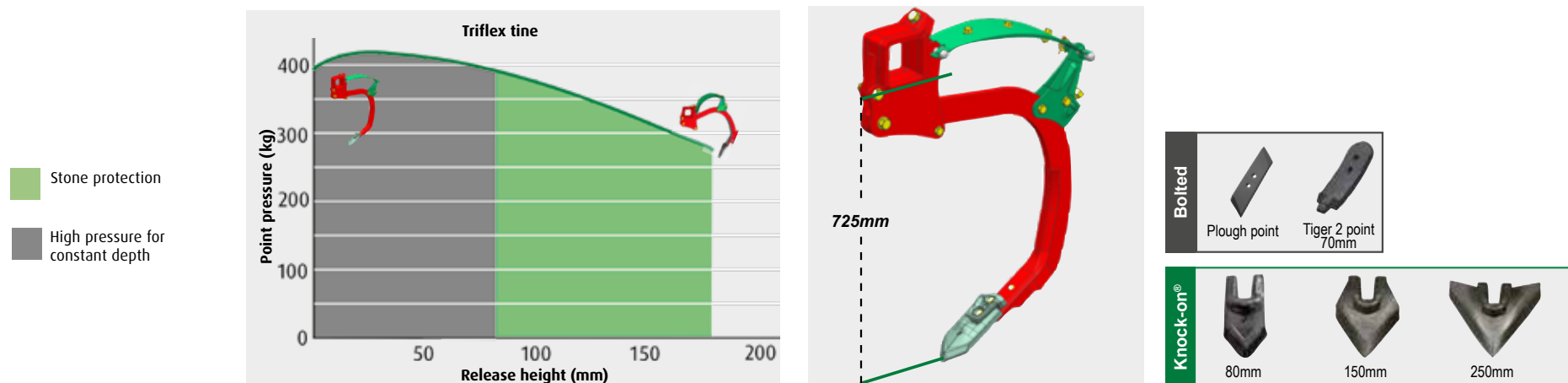

# PERFECT LEVELLING

## LEAVING AN EVEN SURFACE

In order to create an even surface for a fine seedbed, Kverneland offers two options of levelling tools for the Turbo. There are **levelling tines** which are a very easy and economic way of levelling and to handle normal straw conditions on light to medium soil types.

When it comes to heavy amounts of residues and also more clay or loamy soils the **levelling discs** are more suitable.

Both versions are overload protected by a spring to avoid damages in stony or other difficult conditions. Individual springs ensure individual release of tines or discs and keep levelling quality even in stony conditions. The pressure on this spring and also the angle of the levelling discs/tines can be adjusted for a perfect result.

To respect the transport width on the Turbo mounted versions with 3.00m and 3.50m working width the outer tines/discs can be hydraulically or mechanically folded in.











# CONSOLIDATION

## FIRM SEEDBED

The roller on a cultivator is an elementary tool with different tasks:

- Supporting the working depth of the machine
- Consolidation of the soil to have best seed-to-soil contact
- Breaking of clods in order to have a fine seedbed
- Finalising the levelling of the surface

### *Cracking performance.*

The choice of the right roller depends on the soil type and conditions. Also the lifting capacity of the tractor needs to be considered when looking for the right combination.

### **Depth control**

The rear depth control of the Kverneland Turbo is adjusted via the roller equipment. The roller attachment concept enables the working depth to be easily adjusted by spindle. The levelling tine sections are simultaneously adjusted with the roller but can, if necessary, be fine-tuned.

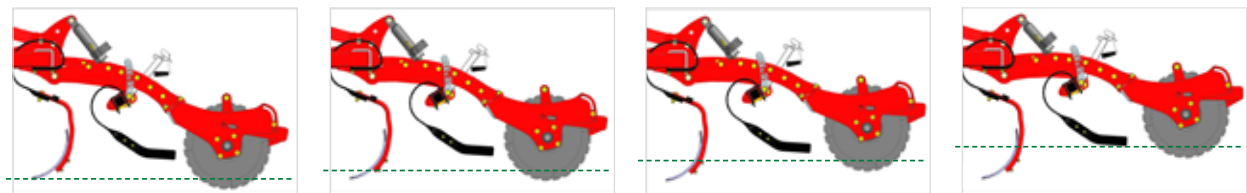

# CONSOLIDATION

## ROLLERS FOR ALL TYPES OF SOIL



### Actipack Ø 560mm - 205 kg/m

- The Actipack roller displays its superb working qualities especially on medium to heavy soils and also in wet, stony and sticky conditions thanks to the independent skids and knives.
- The cutting discs break the larger clods whilst the adjustable knives cut the remaining clods resulting in optimal clod breakdown and fine seedbed preparation.



### Actiring ø 540mm - 160 kg/m

- The Actiring roller is a lighter variant of the Actipack, using the same frame structure and knife system.
- The discs have been replaced by a "V" profile ring, this is saving 60kg/m, which is of critical importance for reducing lifting requirements for mounted equipment.
- Actiring is not recommended in stony conditions.



### Actiflex ø 580mm - 160 kg/m

- The Actiflex roller has been made to create an intensive mixing with all types of conditions, even stony ones.
- The rings are made with spring steel to have a high resistance against stress at high speed.
- Actiflex rings are separated by skids to prevent any accumulation inside the roller.
- This roller is the ideal tool to create a nice seedbed and enhance the weeds regrowth after harvesting.



Work done with an Actipack/  
Actiring roller: left side skids  
lifted up (not active), right side  
skids down in action.



**Actipress Twin ø 560mm - 220kg/m**

- U-profile for high carrying /rolling capacity in light soils
- Clod breaking also in heavy conditions
- Possibility to make different soil profiles by locking the rocking (even or corrugated)
- Self-cleaning effect thanks to the twin u-ring concept
- High stability thanks to the oscillating frame
- High and homogenous consolidation
- Can also work in stony conditions
- Weight/m when full of soil : 250 kg/m



**Cage roller ø 550mm - 90 kg/m**

- 10 bars for a good loading capacity and operation in wet conditions
- Effective crumbling action



**Double cage roller ø 400mm (tube/flat) - 160 kg/m**

- Good crumbling and levelling effect
- Precise depth control
- High carrying capacity

- **Operator-friendly due to maintenance-free bearings**
- **Protection against dust and water with 5 sealing lips**
- **Extended lifetime: Protection of bearings with an additional steel cover in heavier conditions like stones, twine, mud etc.**

## SAFE ON THE ROAD EASY TO CONVERT

Easy conversion from working to transport position. The three-part hydraulic folding gives a transport width of 3.00m and ensures smooth running and safe road transport.

The Turbo T models are homologated\* at 40km/h in Germany and 25km/h in France.



\* see local road regulations.



### **Improved seedbed preparation**

*Since switching to a Kverneland Turbo cultivator, Shropshire farming business RC Evans has noticed a big improvement in seedbed quality, which it expects to translate into higher yields. "We had been using a 3m cultivator on stubbles for min-till," says third generation family farmer Tom Evans, who handles daily duties at the 1,400-acre Curdale Farm at Cleobury Mortimer. An open day event at local dealer Murley Agricultural drew Tom's attention to the Kverneland Turbo cultivator.*

*"The Turbo looked as an useful machine, so we tried it on demo," he says. "Using the same tractor - a New Holland T7.235 - we could pull a 4m Turbo at 6-7in deep, at a speed of 8-9kph." Tom Evans says output has increased by around 40%, to 60 acres/day, enabling the farm to be more productive.*

*"We like to loosen our soils to promote aeration, improve drainage and to advance yields. It is now much easier to remove any wheelings and to aerate heavier soils," he says. "We've also used the Turbo to lift headlands after ploughing, and we've noticed it leaves an even, level finish - not just what you can see on top."*

Tom Evans reckons seedbeds are better aerated and levelled after a pass with the 4m Turbo.





# TURBO T I-TILLER: SMART FARMING CULTIVATOR

## DYNAMIC TRACTION CONTROL AND AUTO-PROTECT

The Kverneland Turbo T i-Tiller has been designed to provide the best working quality with the highest output, whilst ensuring the lowest costs of operation. For that reason, the depth- and levelling adjustments are directly controlled from the tractor cab by the ISOBUS terminal.

The working depth and the height of the levelling equipment are easily adjusted by pressing a button on the terminal. Automatically the Smart System of the Turbo T i-Tiller starts to set up all hydraulic cylinders! A front/rear depth adjustment can be done at any time and on the move depending on soil conditions.

The **On-The-Go Dynamic Traction Control** transfers weight from the front gauge wheels to the tractor coupling in order to give more grip and traction to the tractor. In hilly conditions, the pressure is constantly adjusted to maintain always the selected pressure. The result is less fuel consumption, less wearing of the tires by slipping control and a better soil structure by avoiding compactions.

The overload protection system **Auto-Protect** reacts on obstacles or lateral forces (right/left or both together). The Smart System lifts up the machine if values exceed a specific significant level e.g. if the operator misjudges the affected forces on the machine or misuses it by turning the machine without lifting or over reaching the highest pulling force. This guarantees a longer lifetime and a better second hand value.



## KVERNELAND SOIL KIT

### MAINTAINING SOIL STRUCTURE

Without checking the soil profile to identify potential areas of resistance it is not possible to determine the correct depth of any compaction or barriers. This is important when planning operations to resolve any problems. You may already be aware of soil compaction but not have the tools to confirm the extent of the problem. For example, unnecessary effort to correct soil compaction by tilling to a deeper depth can be a waste of time and money.

The Kverneland soil kit within a stable case provides the necessary tools to access the soil profile ahead of any cultivation. It includes a Penetrometer which measures the compaction of soil, a knife, folding ruler, brush, shovel and a pair of working gloves. The Kverneland soil brochure included will also provide useful technical information in choosing the correct cultivation practice.

Please ask your local dealer for the Kverneland SOIL KIT to provide you with the correct equipment to improve your soil health, increase yields, save time and reduce fuel costs.









# MANAGE YOUR FARM AS A BUSINESS WITH OUR ISOMATCH PRECISION FARMING OFFERING

Our precision farming offering is essential in managing your farming business with success. Applying electronics, software, satellite-technology, online tools and Big Data enables you to use your farming equipment more effectively and reach higher profitability of your crops.



*iM FARMING - smart,  
efficient, easy farming*

*Speed up on the path towards  
connected agriculture.  
We offer you numerous options  
and solutions for how to produce  
more with less; utilise inputs  
more efficiently and thereby  
increase profits and  
sustainability.*

## Enhance your success with e-learning

**IsoMatch Simulator** is a free downloadable virtual training program. It simulates all functions of the IsoMatch Universal Terminals and Kverneland ISOBUS machines. Train yourself and make yourself familiar with your machine to avoid errors and enhance your machine performance.

## The best overview in farm management

**IsoMatch FarmCentre** is the first of a series of telematics solutions. This fleet management solution is applicable for your ISOBUS machines in combination with an IsoMatch Tellus GO/PRO. Whether you wish to control your fleet, manage tasks remotely or analyse machine performance data, IsoMatch FarmCentre provides this in an efficient web application, linking implements, tractors, terminals and the cloud in one continuous flow of data and connectivity.





*Improve your performance  
Maximum efficiency, minimum waste*

**Be a PRO in increasing productivity**

The **IsoMatch Tellus PRO** 12-inch terminal provides you with the optimal solution for an all-in-one control system inside the tractor cab. It is the centre for connecting all ISOBUS machines, running precision farming applications and Farm Management Systems. It offers everything you need to get the maximum out of your machines and crop, as well as cost savings in fertiliser, chemicals and seeds by using automatic section control and variable rate control. With the unique dual screen functionality it gives you the

opportunity to view and manage two machines and/or processes simultaneously.

**Easy control management**

The **IsoMatch Tellus GO** is a cost-efficient 7-inch terminal, especially developed for managing the machine in a simple way. Easily set up the machine with the soft keys and simply use the hard keys and rotary switch for optimal control while driving.

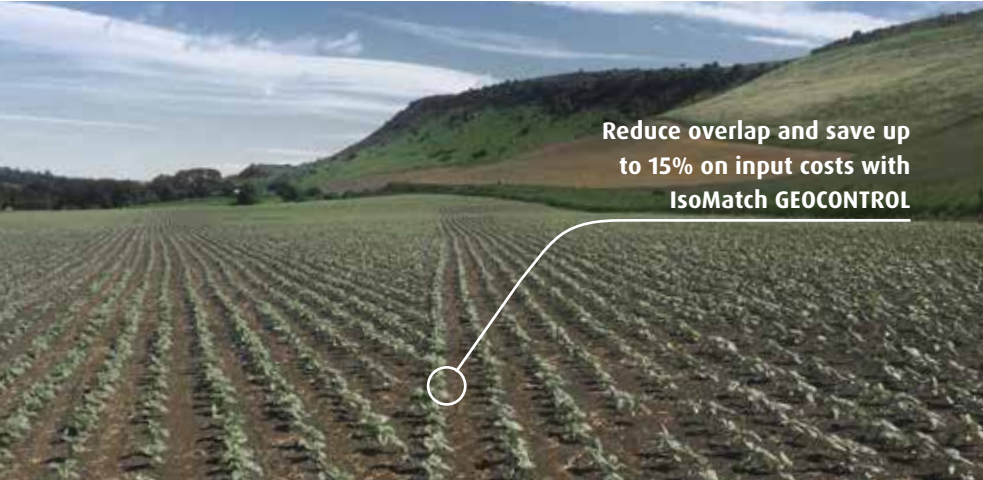

**Reduce overlap and save up to 15% on input costs with IsoMatch GEOCONTROL**

**Maximum savings!**  
*The IsoMatch GEOCONTROL precision farming application includes Manual Guidance and Data Management free of charge. It is possible to expand this application with Section Control and/or Variable Rate Control.*



**IsoMatch Grip**

This ISOBUS auxiliary device is made for maximum machine control and efficient farming. Operate up to 44 implement functions from one device.



**IsoMatch Global**

GPS antenna enabling satellite navigation for site-specific section control, variable rate application, manual guidance and field registration.



**IsoMatch InLine**

Light bar for manual guidance including section status information. Manage the distance from the A-B line and steer for the ideal position.



**IsoMatch (Multi)Eye**

Connect up to 4 cameras to the IsoMatch Universal Terminals. It gives you full control and overview of the entire machine operation.

## ORIGINAL PARTS & SERVICE

# ONLY ORIGINAL PARTS WILL KEEP YOUR MACHINE A KVERNELAND



Did you know that Kverneland parts are manufactured to the same high standards and strict specifications as Kverneland machines? Original Parts will always work and fit as intended, and are guaranteed to keep your machine running at maximum performance.

Kverneland has been a symbol of quality since 1879; the experience we have, combined with a constant strive to improve our products, ensures that the best parts are available for your Kverneland machine. Parts and service surround your machine with a safety-net. The quality of the machine ensures optimal usage and the quality of the parts provide a low life-cycle cost and longer wearing time.

Our long term relationship starts at the purchase of your Kverneland machine, and we will continuously stay by your side for support and assistance. We will guide you on the way to make sure you achieve maximum performance, productivity and profit.

Do not compromise quality with cheap solutions, remember that only Original Kverneland parts are the guaranteed solution to achieve what is expected by a Kverneland machine.



### YOUR PARTS SPECIALIST

Through our worldwide dealer network you will find your local dealer, whom is always prepared to assist you. Your Kverneland dealer knows every inch of your machine and will gladly provide the expertise needed to ensure that you are operating at maximum potential.

Your parts specialist has got all the parts that you need and will also have the facilities to service your machine. Make sure to visit your Kverneland dealer on a regular basis to be updated on promotions and product news that you will not find elsewhere.



### ALWAYS AVAILABLE

Time is money, and we know the importance of receiving the right parts at the right time! Your Kverneland dealer is supported by a massive distribution network to supply you with exactly what you need, when you need it.

Our main distribution centre is located in Metz, France. A strategic location for distributing parts to all corners of the world. With over 70.000 parts in stock and 24/7 service, we are ready to supply you with parts – at any time!



### EASY ACCESS TO INFORMATION

Are you looking for a complete overview of parts for your machine? Maybe you are searching for more technical information? Our Online Search Database, *Quest*, provides all information available for your machine.

Various documentation like Parts Manuals, Operation Manuals, Software updates and FAQ's are all there. *Quest* is available in several different languages and can be accessed wherever and whenever. All answers are easy to find – just a few clicks away !

# TECHNICAL DATA

Model	Turbo 3000	Turbo 3500	Turbo 4000F	Turbo 5000F	Turbo 6000F	Turbo 6500T**	Turbo 8000T**
Frame	mounted rigid	mounted rigid	mounted fold	mounted fold	mounted fold	trailed	trailed
Number of tines	15	17	21	27	31	33	41
Working width (m)	2.82	3.19	3.94	5.07	5.81	6.18	7.68
Roller width (m)	3.00	3.50	4.50	5.50	6.00	6.50	8.00
Number of tine rows	4	4	4	4	4	5	5
Transport width (m)	3.00	3.50	2.90	2.90	2.90	3.00	3.00
Row spacing (mm)	From 550 up to 600					From 510 up to 900	
Linkage	Cat. II & III					Cat. III & IV N, fixed eye	
Underbeam clearance (mm)	725						
Regular tine spacing (mm)	190						
Depth adjustment	Hydraulic by spacers						
Levelling device	Levelling tines or levellings discs						
Roller offering	Cage roller (ø 550mm), Double Cage roller (ø 400mm), Actiring (ø 540mm), Actiflex (ø 580mm), Actipack (ø 560mm), Actipress Twin (ø 560mm) - not on 3.5m rigid & 6m fold						
Transport wheels						2 x 500/60 x 22.5	
Gauge wheels						4 x 340/55 x 16	
Brake						Hydraulic or pneumatic	
Min/Max HP	90/150	105/175	120/200	150/250	180/300	200/350	240/450
Total weight with cage roller (kg)*	1325	1460	2565	2955	3215	5845	6505
Total weight with Actiflex (kg)*	1540	1715	2863	3295	3645	6190	6900
Total weight with Actipack (kg)*	1720	1915	3129	3506	3981	6600	7400

\* Weights are given as an indication.

\*\* Trailed Turbo also as smart Farming cultivator Turbo T i-Tiller available

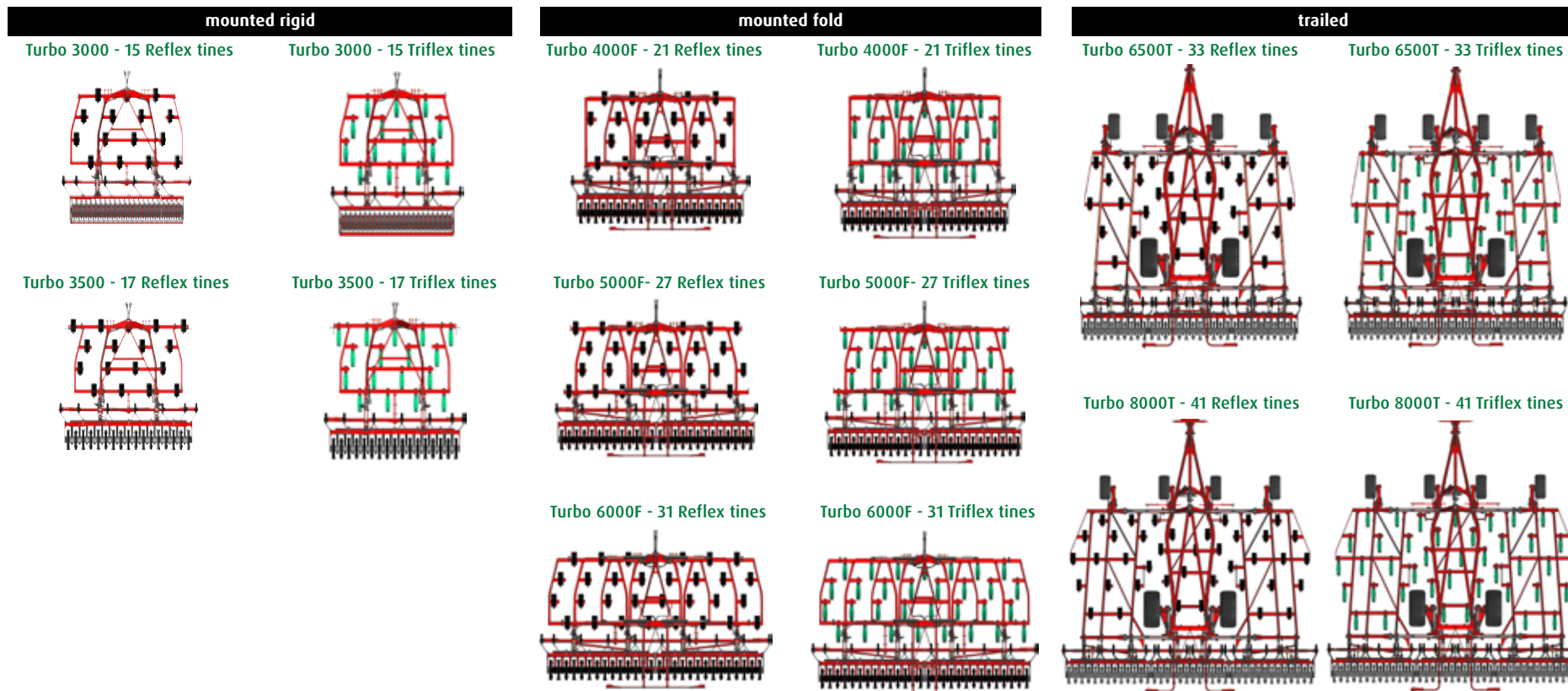

Information provided in this brochure is made for general information purposes only and for worldwide circulation. Inaccuracies, errors or omissions may occur and the information may thus not constitute basis for any legal claim against Kverneland Group. Availability of models, specifications and optional equipment may differ from country to country. Please consult your local dealer. Kverneland Group reserves the right at any time to make changes to the design or specifications shown or described, to add or remove features, without any notice or obligations. Safety devices may have been removed from the machines for illustration purposes only, in order to better present functions of the machines. To avoid risk of injury, safety devices must never be removed. If removal of safety devices is necessary, e.g. for maintenance purposes, please contact proper assistance or supervision of a technical assistant. © Kverneland Group Les Landes Génusson S.A.S.

**WHEN FARMING MEANS BUSINESS**

[kverneland.com](http://kverneland.com)